



SUPER FLOW
MULTIPORT VALVES



Features & Advantages

- 100% water pressure, performance and leakage tested
- Unions sizes in Metric and Imperial standard available
- SS316 spring & screw, non-corrosive in saltwater
- Designed, manufactured and quality controlled by Minder
- Sleek & robust design for long lasting usage
- Laser engraved label marking to prevent fading or peeling off

Warranty

Multipoint Valve | 1 years

MINDER SUPERFLOW Multipoint valves are designed for maximum flow, quietness and durability. It is engineered and constantly improved to withstand working pressure for up to 400kpa (4.0bar) which is suitable for domestic and commercial application. Both top and side mounted and different sizes configuration are available.

Operating Limits

Model	
Maximum water temperature	40°C
Maximum Pressure	4.0bar

1.5" TOP & SIDE - MOUNT 6-ways Multipoint Valve



- 1) Dual-pressure gauge port for flexible installation
- 2) Available in White or Black Color
- 3) Standard Inclusion: Angle-adjustable unions; In-line sight glass on waste Output; Dual Oil Pressure Gauge
- 4) Optional traditional Unions available upon request

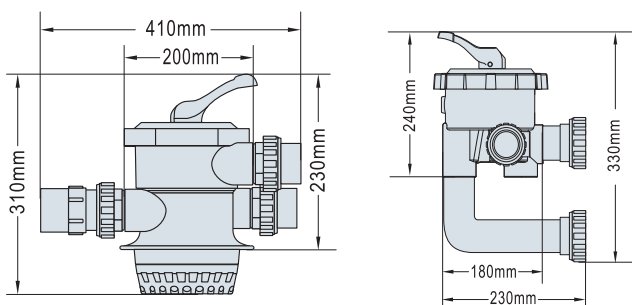

Model	Code	Multipoint Valve Union Size	
		Imperial	Metric
V1.5	70001	1.5"	50mm
VS1.5	70005	1.5"	50mm

2.0" TOP & SIDE - MOUNT 6-ways Multiport Valve



- 1) Available in White or Black Color
- 2) Standard Inclusion: Angle-adjustable unions; Cylinder type Sight glass; Minder Dual Oil Pressure Gauge
- 3) Optional traditional Unions available upon request

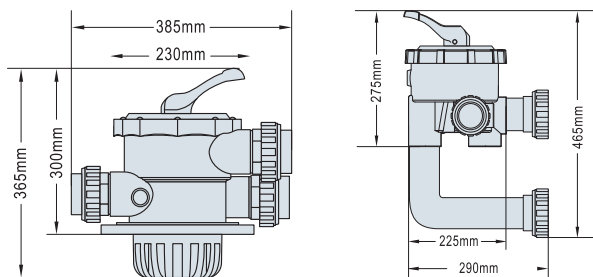

Model	Code	Multiport Valve Union Size	
		Imperial	Metric
V2.0	70002	2.0"	63mm
VS2.0	70006	2.0"	63mm

2.5" TOP & SIDE - MOUNT 6-ways Multiport Valve



- 1) Available in White or Black Color
- 2) Standard Inclusion: Traditional unions; Cylinder type Sight glass; Minder Dual Oil Pressure Gauge

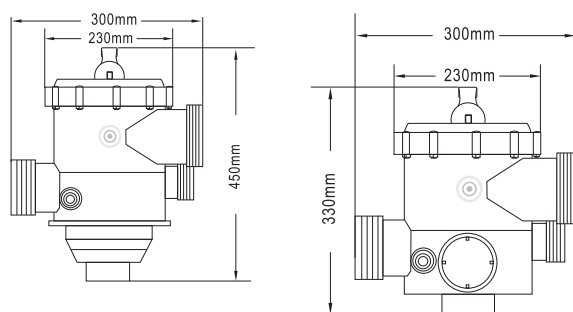

Model	Code	Multiport Valve Union Size	
		Imperial	Metric
V2.5	70923	2.5"	75mm
VS2.5	70924	2.5"	75mm

6-Ways Multiport Valve Position



Minder's Innovative Multiport valve are designed and built with top quality in mind. Our multiport valve is 100% water pressure tested up to 6 bar pressure to ensure no water leakage. Furthermore, we do cycle test, stress test on rotor etc. to make sure the valve has long life.

- **FILTER:** Normal filtration and vacuuming
- **WASTE:** By-passes filter, used for vacuuming waste or lowering water level in pool
- **CLOSED:** Shuts off all flow to filter or pool
- **RINSE:** Use after backwash to flush dirt from valve
- **RECIRCULATE:** By-passes filter to circulate water to pool
- **BACKWASH:** Cleaning filter by reversing the flow

Angle Adjustable Union (New Feature)



Minder's unique design **Angle-adjustable Union** allows up to 15 degree angle adjustable capability which will minimize the system vibration and provide installation flexibility (prevent user installation error). In turn, the product life span is increased.

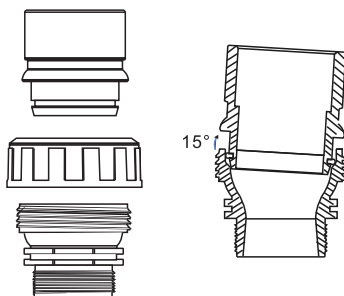

Model	Code	Union Size
		Inch/ mm
1.5" Metric	90511	50mm
1.5" Imperial	90512	1.5"
2.0" Metric	90515	63mm
2.0" Imperial	90516	2.0"



Printed in Australia
By BPA

Distributed internationally by Minder Water Industries Sdn. Bhd. All rights reserved 2018.
Distributed in Australia by Minder Water Industries Pty. Ltd.
Distributed in China by Minder Water Industries (Canton) Co. Ltd.
Distributed in South-East Asia by Minder Water Industries Sdn. Bhd.